



The Leader in LNG Automation.



A Yokogawa Commitment to Industry



Building the future to last.

For more information about these products, please go to promos.us.yokogawa.com and enter KEY CODE ADB307



Mustang - Adding Horsepower to Midstream Projects

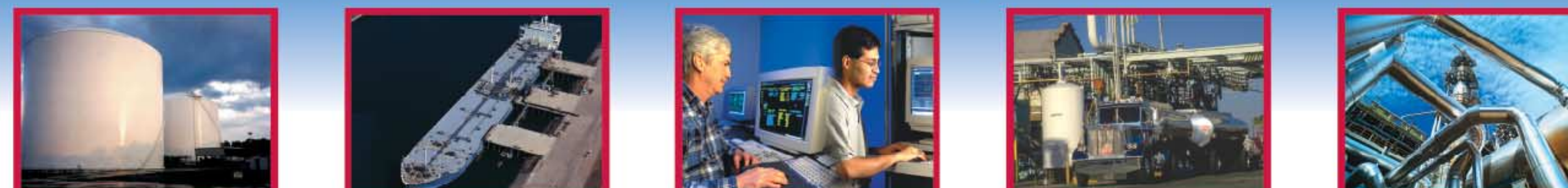

Design Engineering • Project Management • Automation & Control • Startup & Commissioning



www.mustangeng.com

2003 LNG World Trade and Technology

November 2003
Prepared by: Al Kaplan, CC Yang, Zuping Huang, and Veronique Fuller of Foster Wheeler and Graham Marshall of Lloyd's Register
Executive Sponsor: Don Harris of Foster Wheeler
Assistance from: E. Kent Aldridge, SRF Billow
Poster layout and graphics by seaprosop



1700 West Loop South Suite 1000, Houston, TX 77027
Foster Wheeler
Lloyd's Register

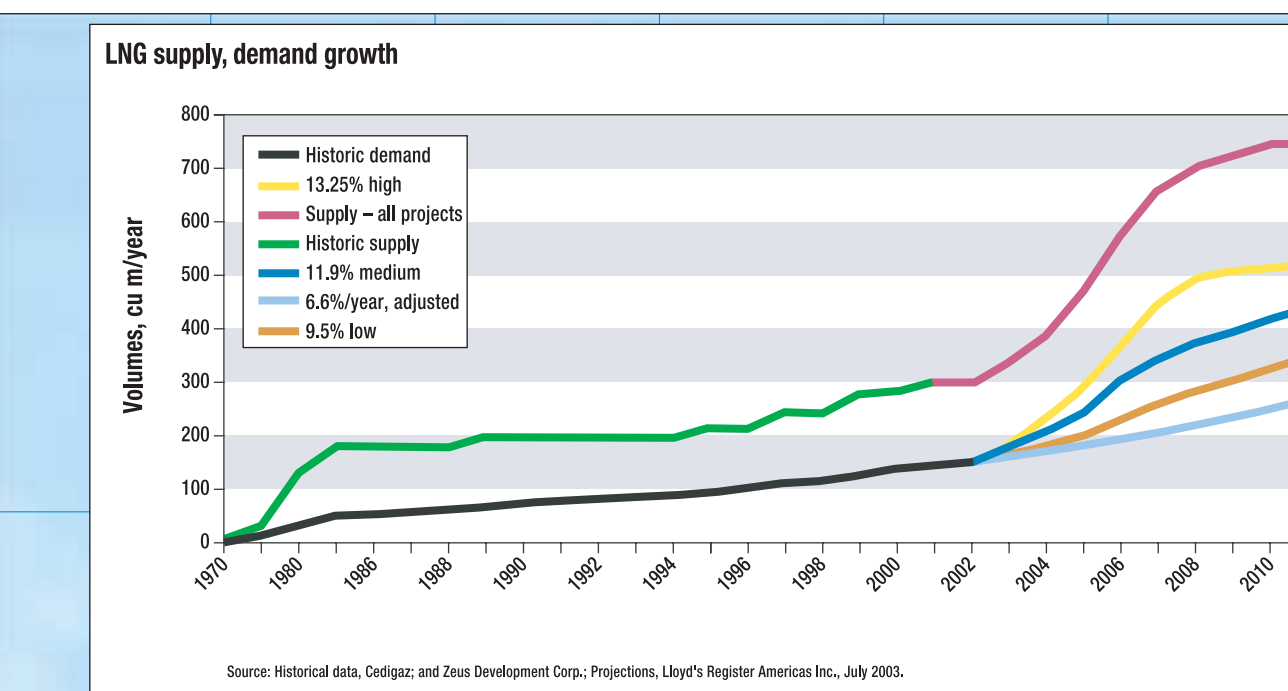
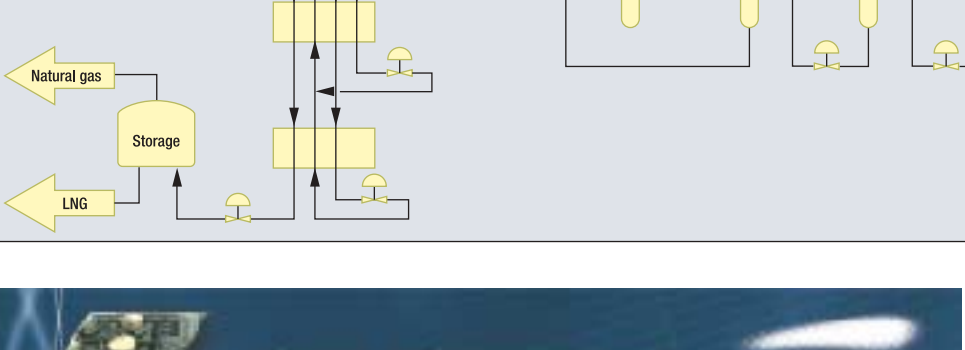
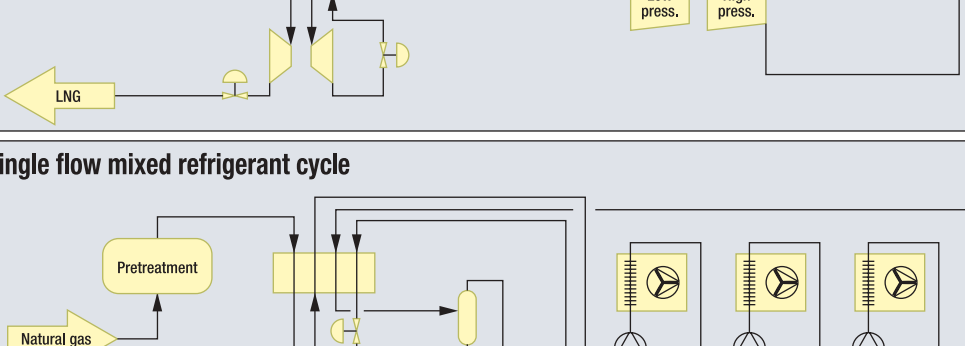
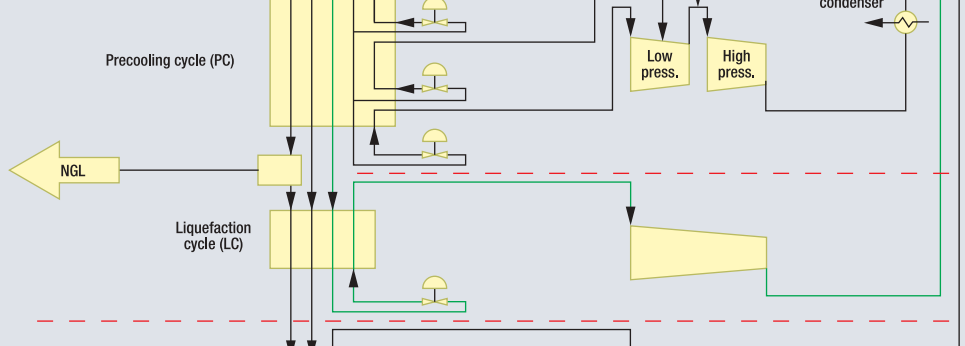
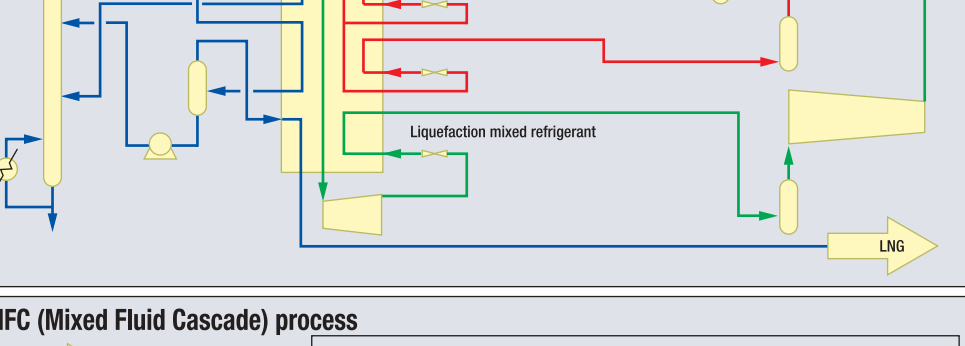
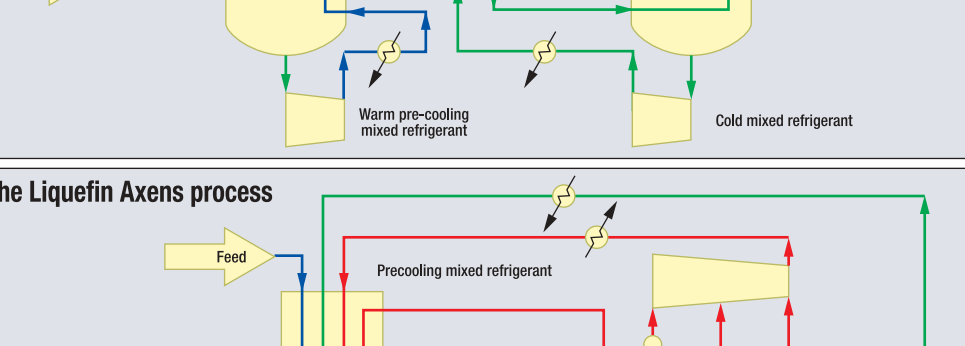
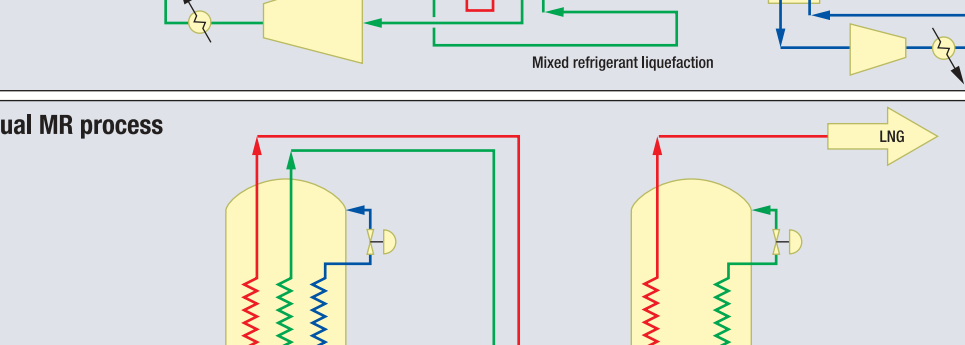
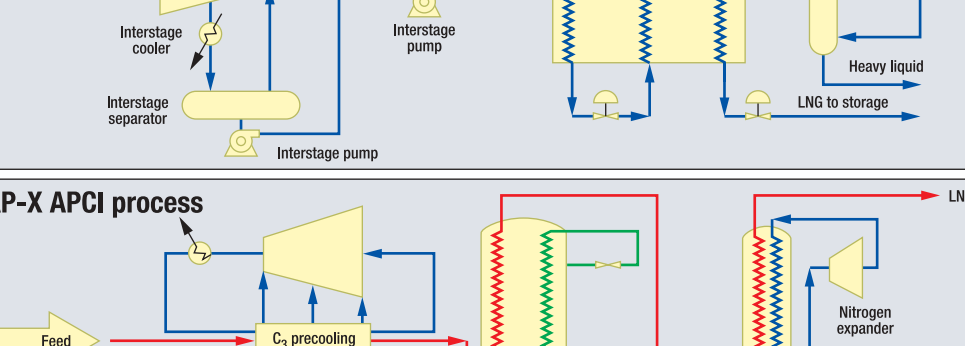
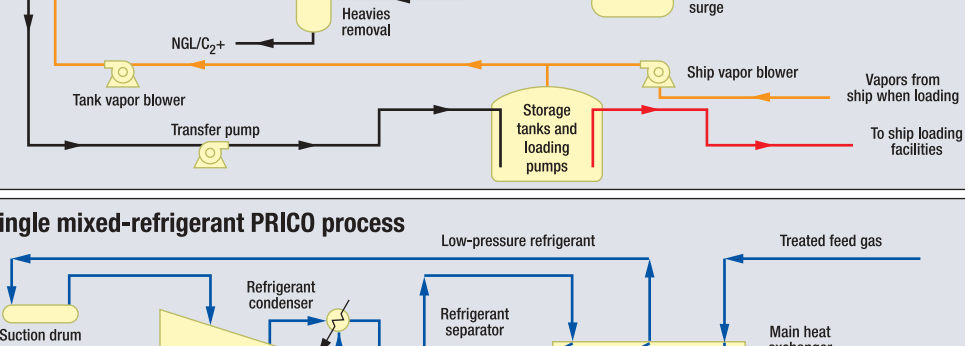
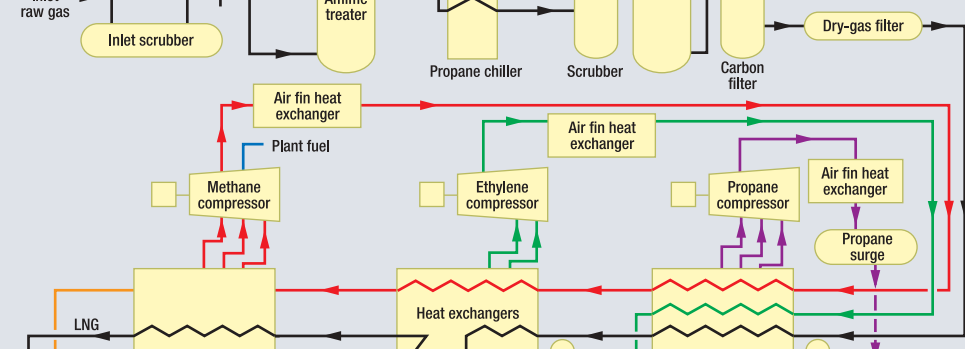
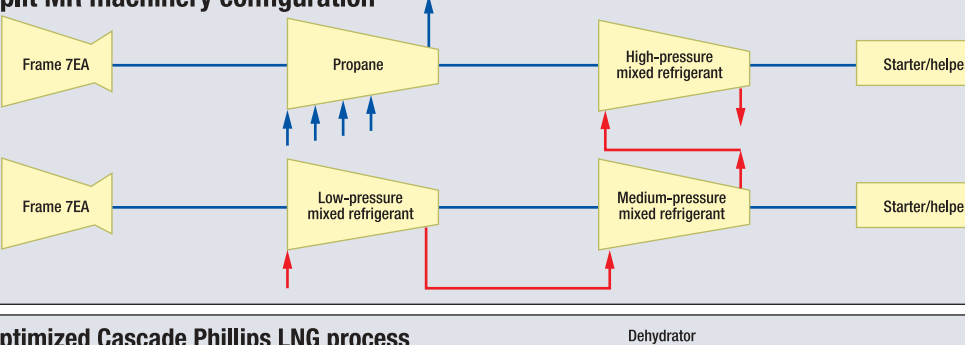
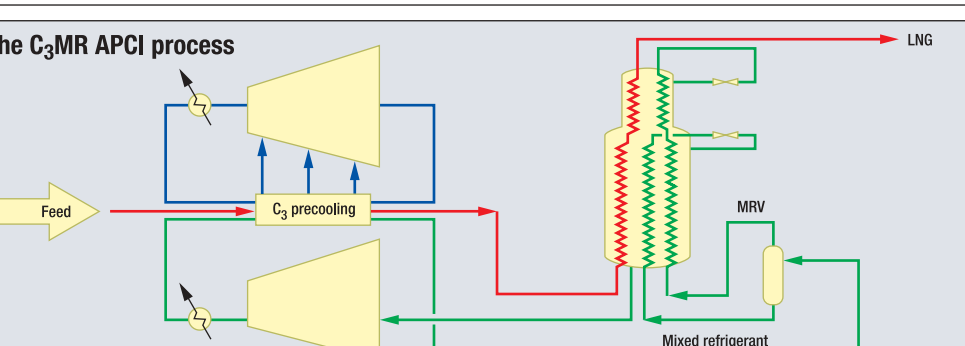

Proved natural gas reserves

Country	Proved gas reserves, bcf	Country	Proved gas reserves, bcf
Russia	1,600,000	Netherlands	62,000
Iran	812,000	Canada	60,118
Qatar LNG	508,540	Spain	34,500
Saudi Arabia	294,200	U.S.	33,320
U.S. On-shore	198,100	France	32,200
U.S. Off-shore	183,460	U.K.	28,400
China	132,700	U.S. Off-shore	28,600
Venezuela*	148,000	Australia	26,000
Nigeria*	124,000	Spain	25,200
India	109,800	U.S. Off-shore	24,600
Indonesia*	92,500	U.S. Off-shore	23,450
Australia*	90,000		
Norway*	77,300		
Algeria*	75,000		
Trinidad and Tobago*	71,000		
Uzbekistan	68,200		
Russia*	65,000		

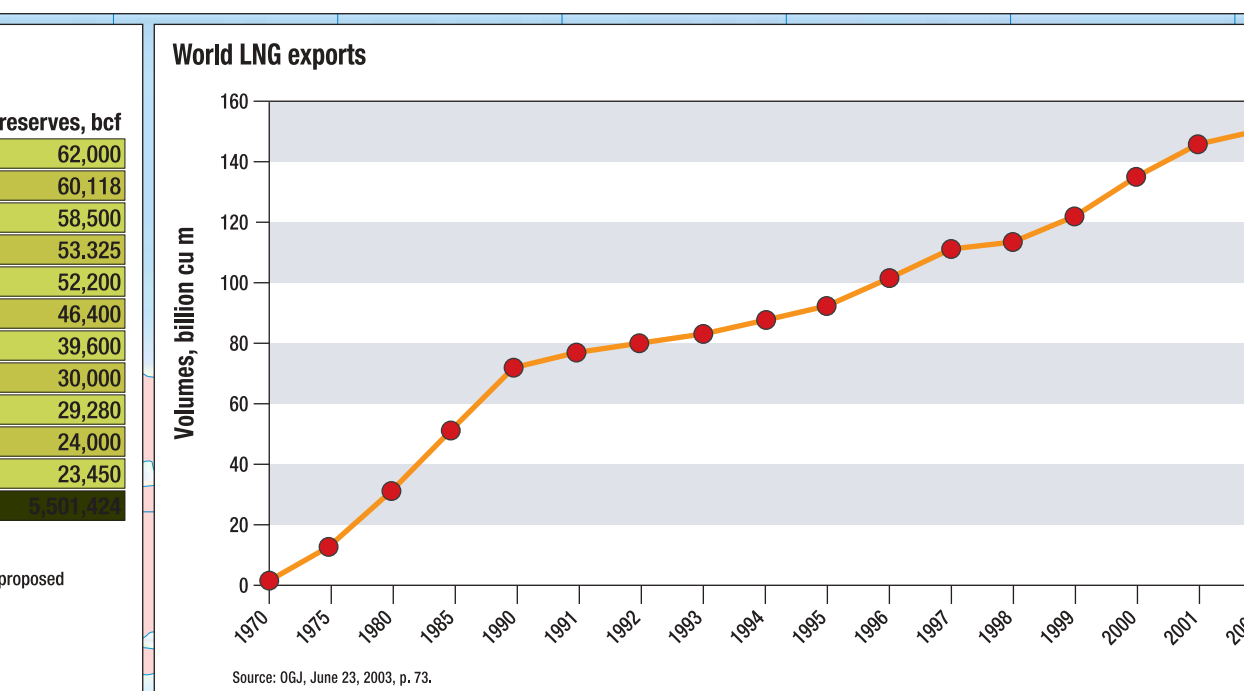

LNG importing countries, 2002

Importing country	Million tonnes	Part of total %	Change from 2001, %
Japan	54.25	40.81	+3.96
Korea	17.84	13.30	+0.96
France	10.25	7.69	+0.30
U.S.	4.33	3.26	+0.10
Spain	3.46	2.61	+0.21
Italy	2.26	1.72	+0.17
Turkey	1.56	1.17	+0.27
Taiwan	1.33	1.00	+0.26
Belgium	2.73	2.07	+0.26
Italy	2.06	1.56	+0.27
Denmark	0.38	0.29	+0.05

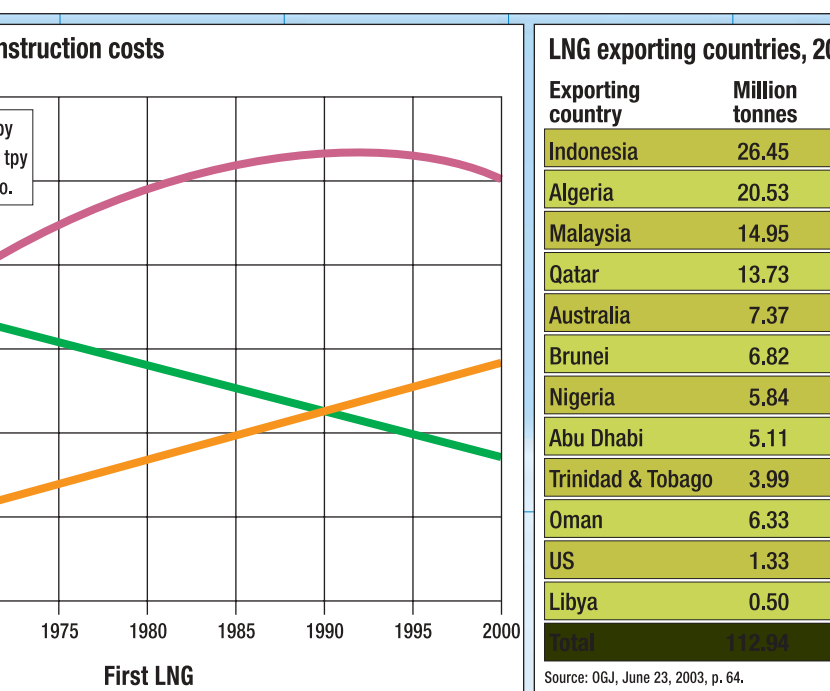

LNG exporting countries, 2002

Exporting country	Million tonnes	Part of total %	Change from 2001, %
Indonesia	26.45	20.42	+1.16
Algeria	20.53	15.81	+0.89
Malaysia	14.95	11.54	+0.34
Qatar	13.73	10.56	+0.43
Australia	7.37	5.62	+0.43
Iran	6.92	5.34	+1.03
Spain	5.84	4.51	+1.07
U.S.	5.11	3.93	+0.21
Taiwan & Hong Kong	3.99	3.03	+0.21
U.S.	3.33	2.56	+0.26
U.S.	2.26	1.72	+0.17
U.S.	0.50	0.38	+0.05

Liquefaction capacity under construction

Project	Capacity million tpy
Algeria LNG, Train 4 & 5	11.2
Northwest Shelf, Train 4	6.2
Malaysia Train 2	7.6
Red Laffan, Train 3	4.7
Spain, Train 3	3.6
Spain, Train 4	3.6
Spain, Train 5	3.6
Spain, Train 6	3.6
Spain, Train 7	3.6
Spain, Train 8	3.6
Spain, Train 9	3.6
Spain, Train 10	3.6
Spain, Train 11	3.6
Spain, Train 12	3.6
Spain, Train 13	3.6
Spain, Train 14	3.6
Spain, Train 15	3.6
Spain, Train 16	3.6
Spain, Train 17	3.6
Spain, Train 18	3.6
Spain, Train 19	3.6
Spain, Train 20	3.6

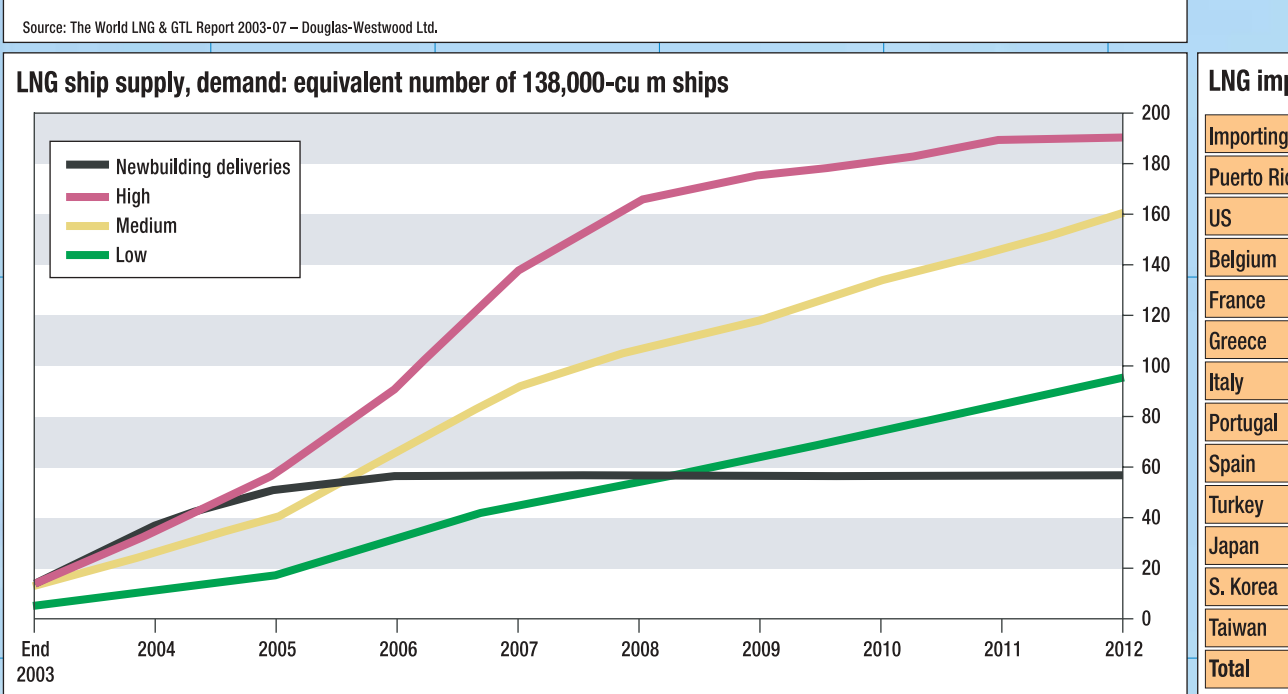
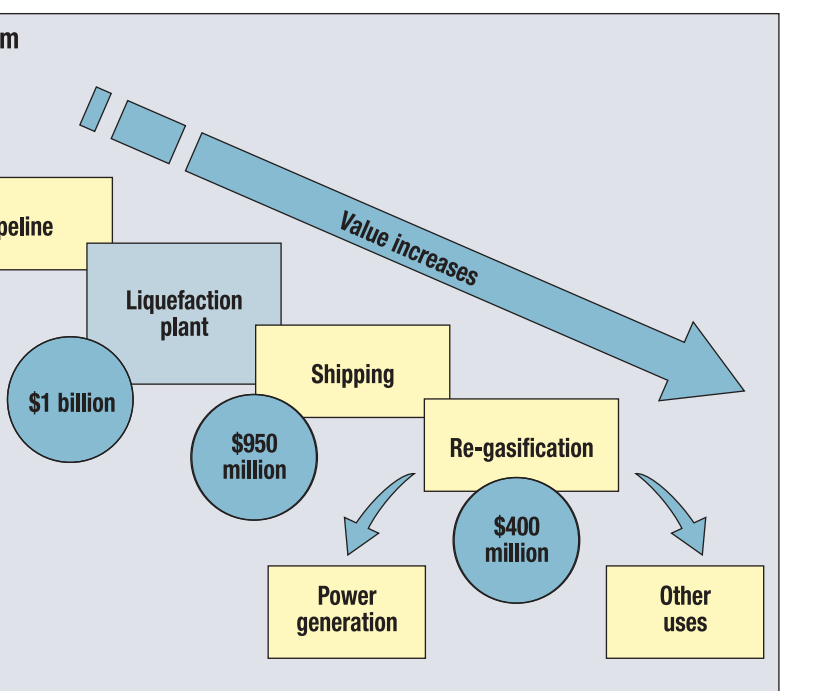
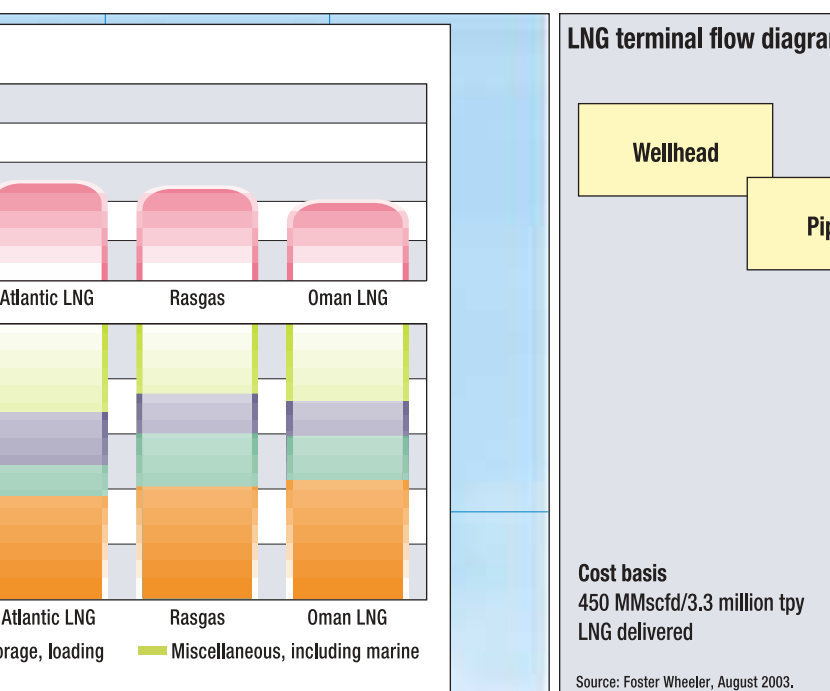
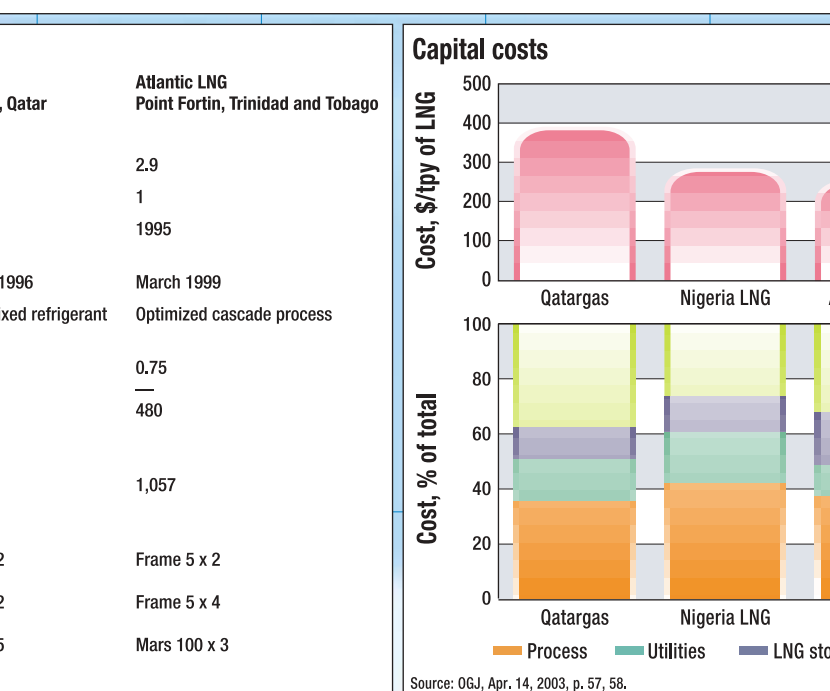

LNG imported by tanker: 2003 (million tonnes)

Importing country	US	Taiwan	Oman	Qatar	Abu Dhabi	Algeria	Spain	France	U.S.	Japan	Malaysia	S. Korea			
Spain	0.58	0.05	0.05	0.05	0.05	0.05	0.05	0.05	0.05	0.05	0.05	0.05			
U.S.	4.28	0.09	0.09	0.09	0.09	0.09	0.09	0.09	0.09	0.09	0.09	0.09			
France	0.54	0.04	0.04	0.04	0.04	0.04	0.04	0.04	0.04	0.04	0.04	0.04			
U.S.	0.50	0.03	0.03	0.03	0.03	0.03	0.03	0.03	0.03	0.03	0.03	0.03			
Italy	2.20	0.03	0.03	0.03	0.03	0.03	0.03	0.03	0.03	0.03	0.03	0.03			
Portugal	0.46	0.02	0.02	0.02	0.02	0.02	0.02	0.02	0.02	0.02	0.02	0.02			
Spain	1.00	0.02	0.02	0.02	0.02	0.02	0.02	0.02	0.02	0.02	0.02	0.02			
Taiwan	1.70	1.00	0.80	0.80	0.80	0.80	0.80	0.80	0.80	0.80	0.80	0.80			
S. Korea	5.40	0.80	0.80	0.80	0.80	0.80	0.80	0.80	0.80	0.80	0.80	0.80			
Japan	1.70	1.00	0.80	0.80	0.80	0.80	0.80	0.80	0.80	0.80	0.80	0.80			
Total	1.70	5.32	7.96	16.59	6.85	26.40	0.63	7.77	10.63	9.14	34.33	6.15	26.52	0.65	184.64

